

# LM3509

## High Efficiency Boost for White LED's and/or OLED Displays with Dual Current Sinks and I<sup>2</sup>C Compatible Brightness Control

### General Description

The LM3509 current mode boost converter offers two separate outputs. The first output (MAIN) is a constant current sink for driving series white LED's. The second output (SUB/FB) is configurable as a constant current sink for series white LED bias, or as a feedback pin to set a constant output voltage for powering OLED panels.

When configured as a dual output white LED bias supply, the LM3509 adaptively regulates the supply voltage of the LED strings to maximize efficiency and insure the current sinks remain in regulation. The maximum current per output is set via a single external low power resistor. An I<sup>2</sup>C compatible interface allows for independent adjustment of the LED current in either output from 0 to max current in 32 exponential steps. When configured as a white LED + OLED bias supply the LM3509 can independently and simultaneously drive a string of up to 5 white LED's and deliver a constant output voltage of up to 21V for OLED panels.

Output over-voltage protection shuts down the device if V<sub>OUT</sub> rises above 21V allowing for the use of small sized low voltage output capacitors. The LM3509 is offered in a small 10-pin thermally- enhanced LLP package and operates over the -40°C to +85°C temperature range.

### Features

- Integrated OLED Display Power Supply and LED Driver
- Drives up to 10 LED's at 30mA
- Drives up to 5 LED's at 20mA and delivers up to 21V at 40mA
- Over 90% Efficient
- 32 Exponential Dimming Steps
- 0.15% Accurate Current Matching Between Strings
- Internal Soft-Start Limits Inrush Current
- True Shutdown Isolation for LED's
- Wide 2.7V to 5.5V Input Voltage Range
- 21V Over-Voltage Protection
- 1.27MHz Fixed Frequency Operation
- Low Profile 10-pin LLP Package (3mm x 3mm x 0.8mm)
- General Purpose I/O
- Active Low Hardware Reset

### Applications

- Dual Display LCD Backlighting for Portable Applications
- Large Format LCD Backlighting
- OLED Panel Power Supply

### Typical Application Circuits

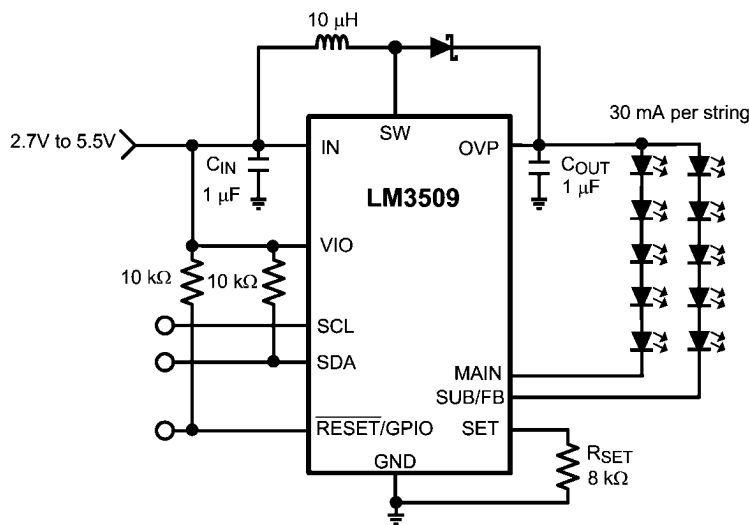

Dual White LED Bias Supply

30004361

LM3509 High Efficiency Boost for White LED's and/or OLED Displays with Dual Current Sinks and I<sup>2</sup>C Compatible Brightness Control

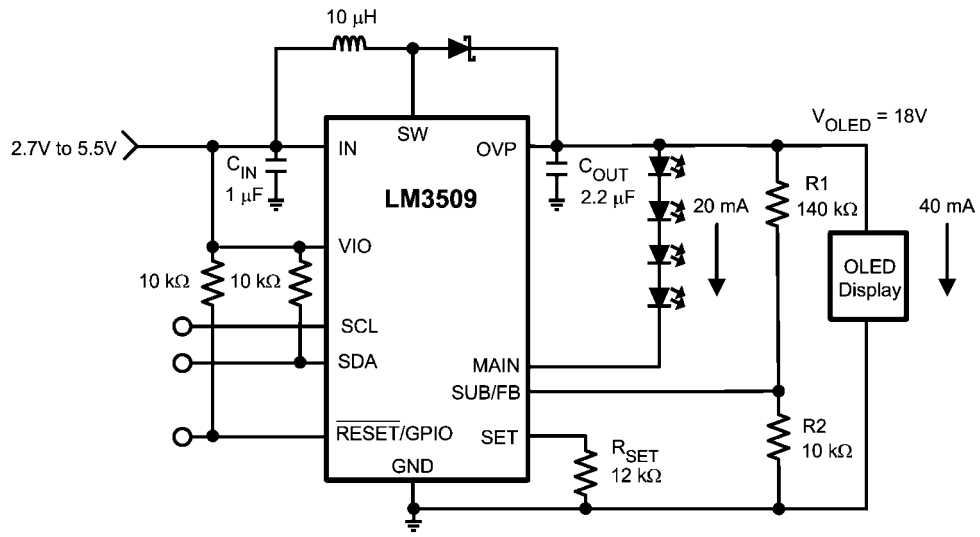

OLED Panel Power Supply

30004301

## Connection Diagram

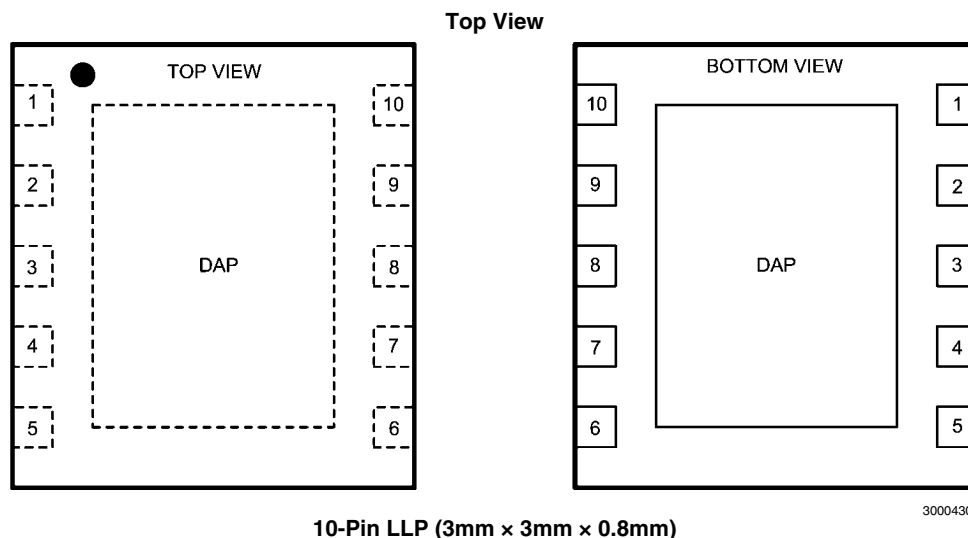

## Ordering Information

Order Number	Package Type	NSC Package Drawing	Top Mark	Supplied As
LM3509SD	10-Pin LLP	SDA010A	L3509	1000 units, Tape-and-Reel, No-Lead
LM3509SDX	10-Pin LLP	SDA010A	L3509	4500 units, Tape-and-Reel, No Lead

## Pin Descriptions/Functions

Pin	Name	Function
1	MAIN	Main Current Sink Input.
2	SUB/FB	Secondary Current Sink Input or 1.25V Feedback Connection for Constant Voltage Output.
3	SET	LED Current Setting Connection. Connect a resistor from SET to GND to set the maximum LED current into MAIN or SUB/FB (when in LED mode), where $I_{LED\_MAX} = 192 \times 1.244V / R_{SET}$ .
4	VIO	Logic Voltage Level Input
5	RESET/GPIO	Active Low Hardware Reset and Programmable General Purpose I/O.
6	SW	Drain Connection for Internal NMOS Switch
7	OVP	Over-Voltage Protection Sense Connection. Connect OVP to the positive terminal of the output capacitor.
8	IN	Input Voltage Connection. Connect IN to the input supply, and bypass to GND with a 1 $\mu$ F ceramic capacitor.
9	SDA	Serial Data Input/Output
10	SCL	Serial Clock Input
DAP	GND	Ground

## Absolute Maximum Ratings (Notes 1, 2)

If Military/Aerospace specified devices are required, please contact the National Semiconductor Sales Office/Distributors for availability and specifications.

$V_{IN}$	-0.3V to 6V
$V_{SW}, V_{OVP}$	-0.3V to 25V
$V_{SUB/FB}, V_{MAIN}$	-0.3V to 23V
$V_{SCL}, V_{SDA}, V_{RESET/GPIO}, V_{IO}, V_{SET}$	-0.3V to 6V
Continuous Power Dissipation	Internally Limited
Junction Temperature ( $T_{J-MAX}$ )	+150°C
Storage Temperature Range	-65°C to +150°C
Maximum Lead Temperature (Soldering, 10s)(Note 3)	+300°C
ESD Rating(Note 10)	
Human Body Model	2.5kV

## Operating Ratings (Notes 1, 2)

$V_{IN}$	2.7V to 5.5V
$V_{SW}, V_{OVP}$	0V to 23V
$V_{SUB/FB}, V_{MAIN}$	0V to 21V
Junction Temperature Range ( $T_J$ )(Note 4)	-40°C to +110°C
Ambient Temperature Range ( $T_A$ )(Note 5)	-40°C to +85°C

## Thermal Properties

Junction to Ambient Thermal Resistance ( $\theta_{JA}$ )(Note 6)	54°C/W
--	--------

## ESD Caution Notice

National Semiconductor recommends that all integrated circuits be handled with appropriate ESD precautions. Failure to observe proper ESD handling techniques can result in damage to the device.

## Electrical Characteristics

Specifications in standard type face are for  $T_A = 25^\circ\text{C}$  and those in **boldface type** apply over the Operating Temperature Range of  $T_A = -40^\circ\text{C}$  to  $+85^\circ\text{C}$ . Unless otherwise specified  $V_{IN} = 3.6\text{V}$ ,  $V_{IO} = 1.8\text{V}$ ,  $V_{RESET/GPIO} = V_{IN}$ ,  $V_{SUB/FB} = V_{MAIN} = 0.5\text{V}$ ,  $R_{SET} = 12.0\text{k}\Omega$ ,  $OLED = '0'$ ,  $ENM = ENS = '1'$ ,  $BSUB = BMAIN = \text{Full Scale}$ .(Notes 2, 7)

Symbol	Parameter	Conditions	Min	Typ	Max	Units
$I_{LED}$	Output Current Regulation MAIN or SUB/FB Enabled	UNI = '0', or '1'	<b>18.6</b>	20	<b>21.8</b>	mA
	Maximum Current Per Current Sink	$R_{SET} = 8.0\text{k}\Omega$		30		
$I_{LED-MATCH}$	$I_{MAIN}$ to $I_{SUB/FB}$ Current Matching	UNI = '1' (Note 11)		0.15	<b>1</b>	%
$V_{SET}$	SET Pin Voltage	$3.0\text{V} < V_{IN} < 5\text{V}$		1.244		V
$I_{LED}/I_{SET}$	$I_{LED}$ Current to $I_{SET}$ Current Ratio			192		
$V_{REG\_CS}$	Regulated Current Sink Headroom Voltage			500		mV
$V_{REG\_OLED}$	$V_{SUB/FB}$ Regulation Voltage in OLED Mode	$3.0\text{V} < V_{IN} < 5.5\text{V}$ , $OLED = '1'$	<b>1.172</b>	1.21	<b>1.239</b>	V
$V_{HR}$	Current Sink Minimum Headroom Voltage	$I_{LED} = 95\%$ of nominal		300		mV
$R_{DSON}$	NMOS Switch On Resistance	$I_{SW} = 100\text{mA}$		0.58		$\Omega$
$I_{CL}$	NMOS Switch Current Limit	$V_{IN} = 3.0\text{V}$	<b>650</b>	770	<b>875</b>	mA
$V_{OVP}$	Output Over-Voltage Protection	ON Threshold	<b>21.2</b>	22	<b>22.9</b>	V
		OFF Threshold	<b>19.7</b>	20.6	<b>21.2</b>	
$f_{SW}$	Switching Frequency		<b>1.0</b>	1.27	<b>1.4</b>	MHz
$D_{MAX}$	Maximum Duty Cycle			90		%
$D_{MIN}$	Minimum Duty Cycle			10		%
$I_Q$	Quiescent Current, Device Not Switching	$V_{MAIN}$ and $V_{SUB/FB} >$ $V_{REG\_CS}$ , $BSUB = BMAIN =$ $0x00$		400	<b>440</b>	$\mu\text{A}$
		$V_{SUB/FB} > V_{REG\_OLED}$ , $OLED = '1'$ , $ENM = ENS = '0'$		250	<b>305</b>	
$I_{SHDN}$	Shutdown Current	$ENM = ENS = OLED = '0'$		3.6	<b>5</b>	$\mu\text{A}$

Symbol	Parameter	Conditions	Min	Typ	Max	Units
<b>RESET/GPIO Pin Voltage Specifications</b>						
$V_{IL}$	Input Logic Low	$2.7V < V_{IN} < 5.5V$ , MODE bit = 0			<b>0.5</b>	V
$V_{IH}$	Input Logic High	$2.7V < V_{IN} < 5.5V$ , MODE bit = 0	<b>1.1</b>			V
$V_{OL}$	Output Logic Low	$I_{LOAD}=3mA$ , MODE bit = 1			<b>400</b>	mV
<b>I<sup>2</sup>C Compatible Voltage Specifications (SCL, SDA, VIO)</b>						
$V_{IO}$	Serial Bus Voltage Level	$2.7V < V_{IN} < 5.5V$ (Note 9)	<b>1.4</b>		$V_{IN}$	V
$V_{IL}$	Input Logic Low	$2.7V < V_{IN} < 5.5V$			<b><math>0.36 \times V_{IO}</math></b>	V
$V_{IH}$	Input Logic High	$2.7V < V_{IN} < 5.5V$	<b><math>0.7 \times V_{IO}</math></b>		$V_{IO}$	V
$V_{OL}$	Output Logic Low	$I_{LOAD} = 3mA$			<b>400</b>	mV
<b>I<sup>2</sup>C Compatible Timing Specifications (SCL, SDA, VIO, see Figure 1) (Notes 8, 9)</b>						
$t_1$	SCL Clock Period		<b>2.5</b>			$\mu s$
$t_2$	Data In Setup Time to SCL High		<b>100</b>			ns
$t_3$	Data Out Stable After SCL Low		<b>0</b>			ns
$t_4$	SDA Low Setup Time to SCL Low (Start)		<b>100</b>			ns
$t_5$	SDA High Hold Time After SCL High (Stop)		<b>100</b>			ns

**Note 1:** Absolute maximum ratings are limits beyond which damage to the device may occur. Operating Ratings are conditions for which the device is intended to be functional, but device parameter specifications may not be guaranteed. For guaranteed specifications and test conditions, see the Electrical Characteristics.

**Note 2:** All voltages are with respect to the potential at the GND pin.

**Note 3:** For detailed soldering specifications and information, please refer to National Semiconductor Application Note 1187: Leadless Lead frame Package (AN-1187).

**Note 4:** Internal thermal shutdown circuitry protects the device from permanent damage. Thermal shutdown engages at  $T_J=150^\circ C$  (typ.) and disengages at  $T_J=140^\circ C$  (typ.).

**Note 5:** In applications where high power dissipation and/or poor package thermal resistance is present, the maximum ambient temperature may have to be derated. Maximum ambient temperature ( $T_{A-MAX}$ ) is dependent on the maximum operating junction temperature ( $T_{J-MAX-OP} = +105^\circ C$ ), the maximum power dissipation of the device in the application ( $P_{D-MAX}$ ), and the junction-to ambient thermal resistance of the part/package in the application ( $\theta_{JA}$ ), as given by the following equation:  $T_{A-MAX} = T_{J-MAX-OP} - (\theta_{JA} \times P_{D-MAX})$ .

**Note 6:** Junction-to-ambient thermal resistance ( $\theta_{JA}$ ) is taken from a thermal modeling result, performed under the conditions and guidelines set forth in the JEDEC standard JESD51-7. The test board is a 4-layer FR-4 board measuring 114mm x 76mm x 1.6mm with a 2x1 array of thermal vias. The ground plane on the board is 113mm x 75mm. Thickness of copper layers are 71.5 $\mu m$ /35 $\mu m$ /35 $\mu m$ /71.5 $\mu m$  (2oz/1oz/1oz/2oz). Ambient temperature in simulation is 22 $^\circ C$ , still air. Power dissipation is 1W. The value of  $\theta_{JA}$  of this product in the LLP package could fall in a range as wide as 50 $^\circ C/W$  to 150 $^\circ C/W$  (if not wider), depending on board material, layout, and environmental conditions. In applications where high maximum power dissipation exists special care must be paid to thermal dissipation issues. For more information on these topics, please refer to Application Note 1187: Leadless Leadframe Package (LLP) and the Power Efficiency and Power Dissipation section of this datasheet.

**Note 7:** Min and Max limits are guaranteed by design, test, or statistical analysis. Typical (Typ) numbers are not guaranteed, but represent the most likely norm.

**Note 8:** SCL and SDA must be glitch-free in order for proper brightness control to be realized.

**Note 9:** SCL and SDA signals are referenced to VIO and GND for minimum VIO voltage testing.

**Note 10:** The human body model is a 100pF capacitor discharged through 1.5k $\Omega$  resistor into each pin. (MIL-STD-883 3015.7).

**Note 11:** The matching specification between MAIN and SUB is calculated as  $100 \times ((I_{MAIN} \text{ or } I_{SUB}) - I_{AVE}) / I_{AVE}$ . This simplifies out to be  $100 \times (I_{MAIN} - I_{SUB}) / (I_{MAIN} + I_{SUB})$ .

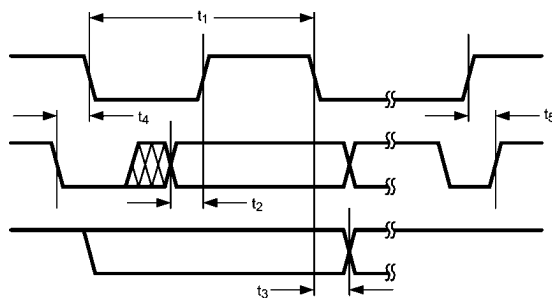

30004303

FIGURE 1. I<sup>2</sup>C Timing

**Typical Performance Characteristics**  $V_{IN} = 3.6V$ , LEDs are OSRAM (LW M67C),  $C_{OUT} = 1\mu F$  (LED Mode),  $C_{OUT} = 2.2\mu F$  (OLED Mode),  $C_{IN} = 1\mu F$ ,  $L = TDK VLF4012AT-100MR79$ , ( $R_L = 0.3\Omega$ ),  $R_{SET} = 8.06k\Omega$ ,  $UNI = '1'$ ,  $I_{LED} = I_{SUB} + I_{MAIN}$ ,  $T_A = +25^\circ C$  unless otherwise specified.

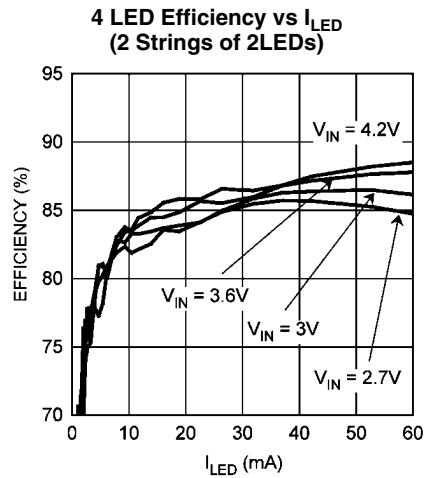
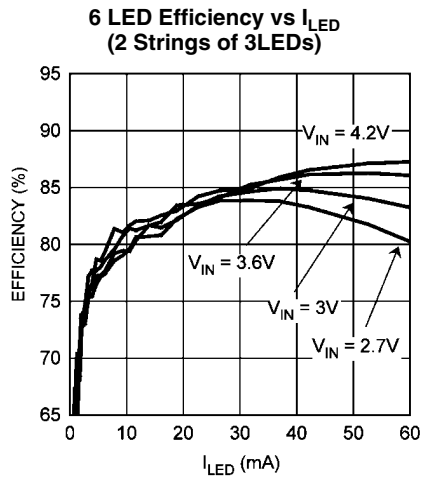
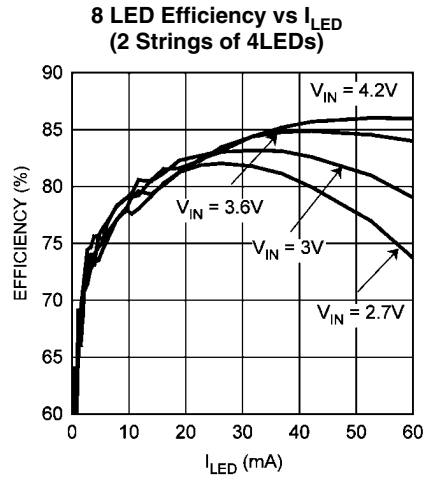
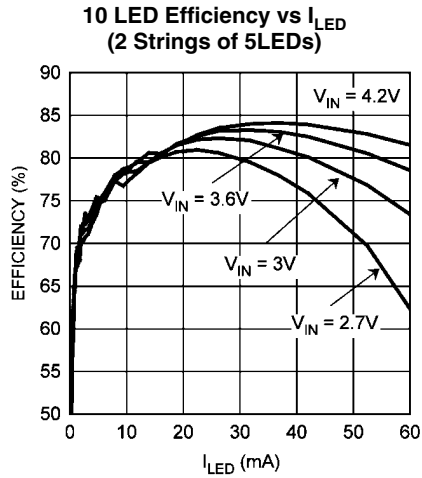

**LED Efficiency vs  $V_{IN}$**   
( $L = TDK VLF3012AT-100MR49$ ,  $R_L = 0.36\Omega$ ,  $I_{LED} = 40mA$ )

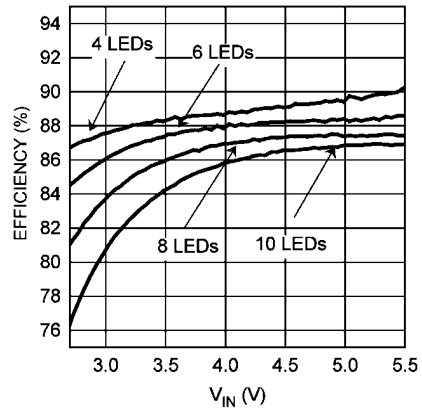

**LED Efficiency vs  $V_{IN}$**   
( $L = TDK VLF5014AT-100MR92$ ,  $R_L = 0.2\Omega$ ,  $I_{LED} = 60mA$ )

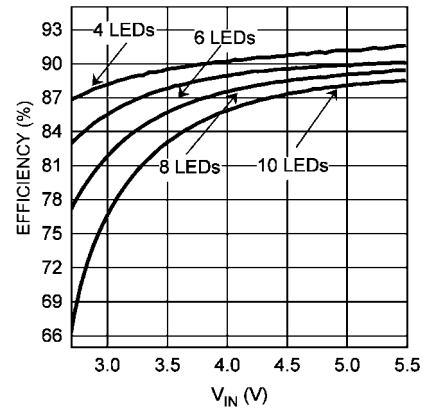

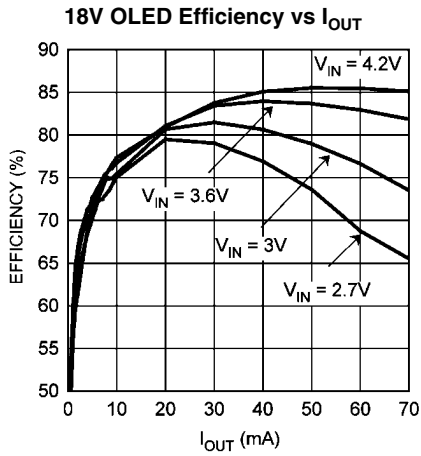

30004304

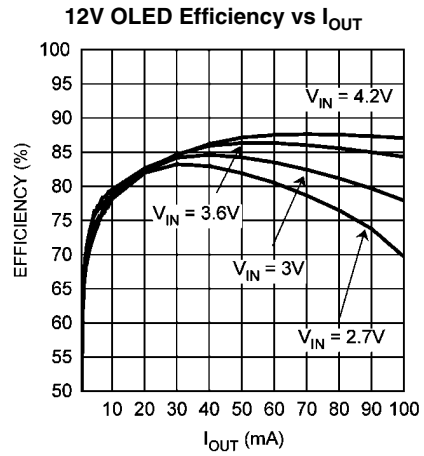

30004305

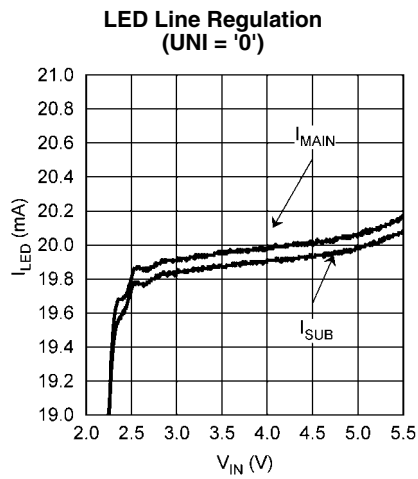

30004359

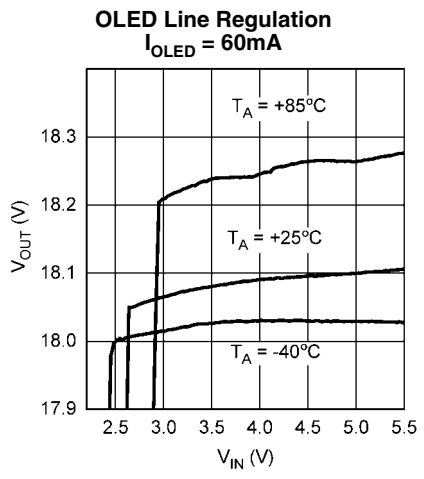

30004307

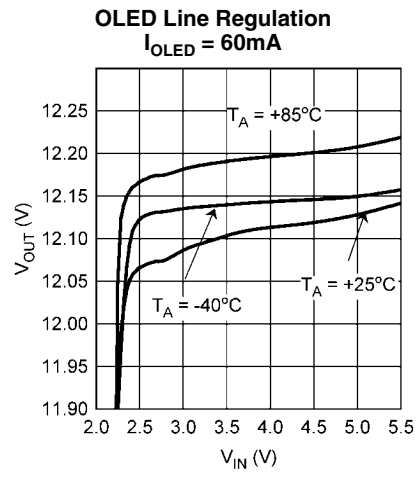

30004306

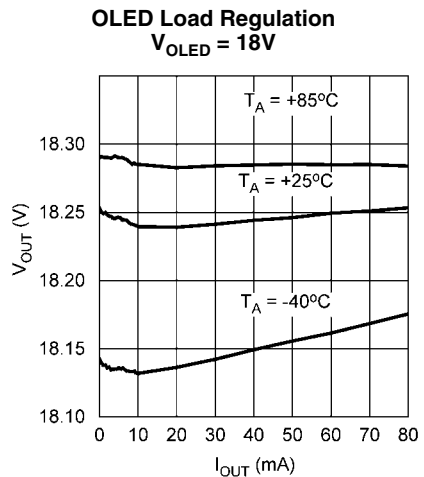

30004313

**OLED Load Regulation**  
 $V_{OLED} = 12V$

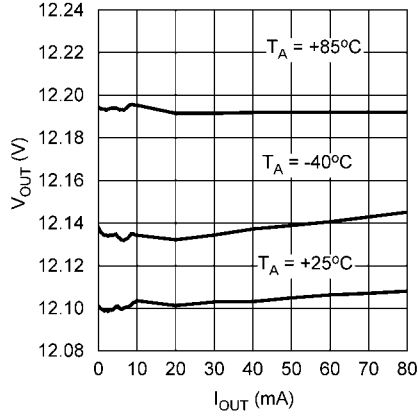

30004312

**Peak Current Limit vs.  $V_{IN}$**

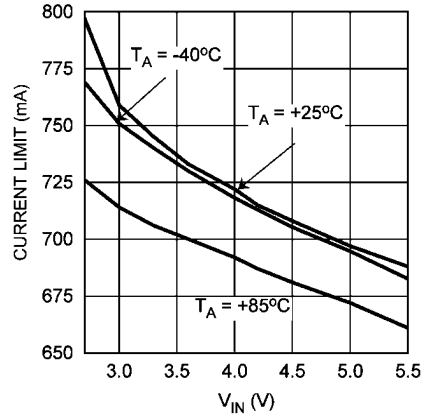

30004314

**Over Voltage Limit vs.  $V_{IN}$**

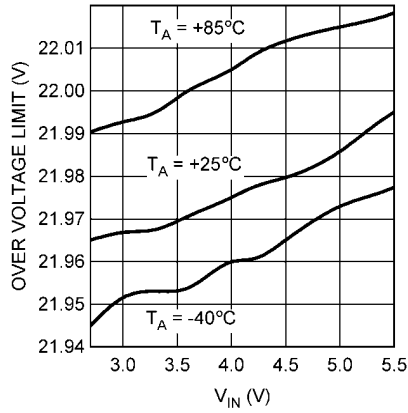

30004315

**Switch On-Resistance vs.  $V_{IN}$**

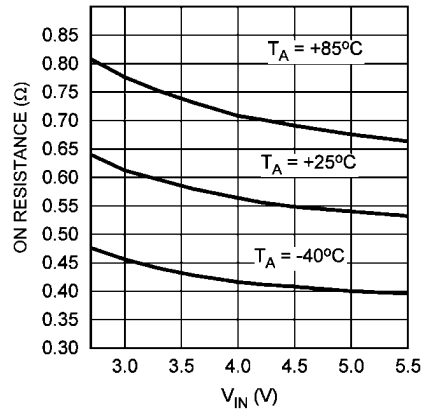

30004317

**Switching Frequency vs.  $V_{IN}$**

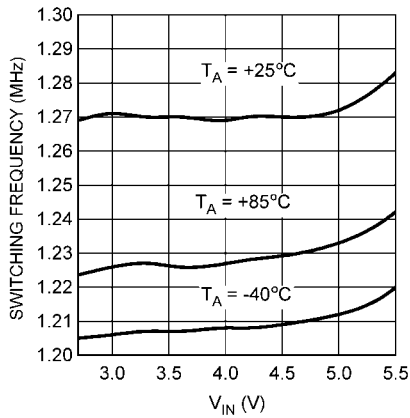

30004318

**Maximum Duty Cycle vs.  $V_{IN}$**

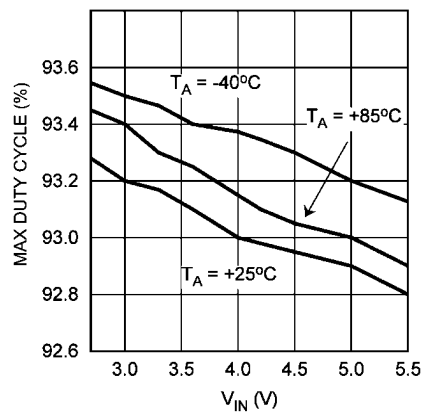

30004319



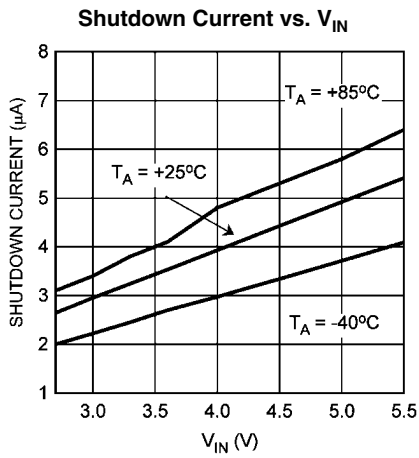

30004320

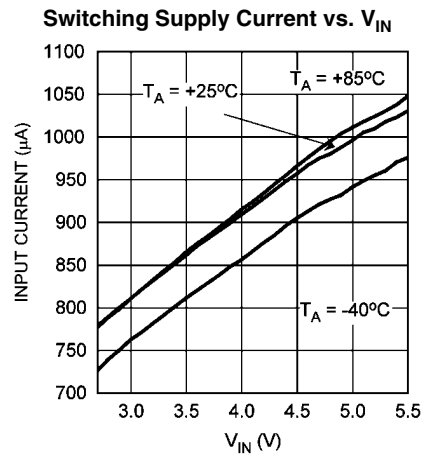

30004321

**LED Current Matching vs. CODE** (Note 11)  
(UNI = '1',  $R_{SET} = 12\text{k}\Omega$ ,  $T_A = -40^\circ\text{C}$  to  $+85^\circ\text{C}$ )

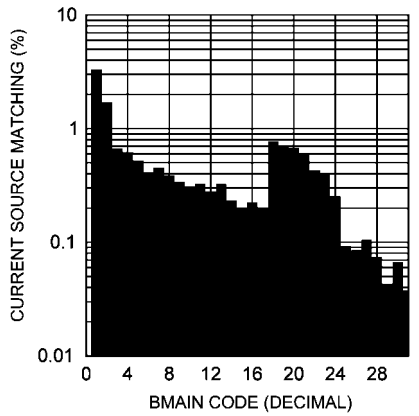

30004322

**LED Current Accuracy vs CODE**  
( $R_{SET} = 12\text{k}\Omega \pm 0.05\%$ )

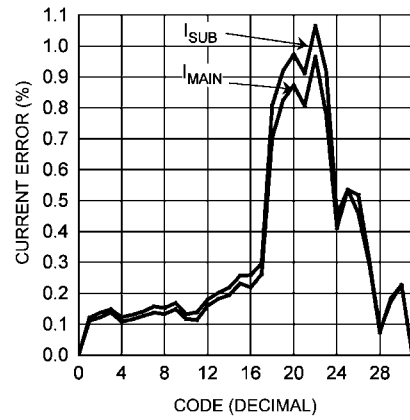

30004323

**LED Current vs CODE**  
( $I_{MAIN}$ ,  $I_{SUB}$ ,  $I_{IDEAL}$ ,  $R_{SET} = 12\text{k}\Omega \pm 0.05\%$ )

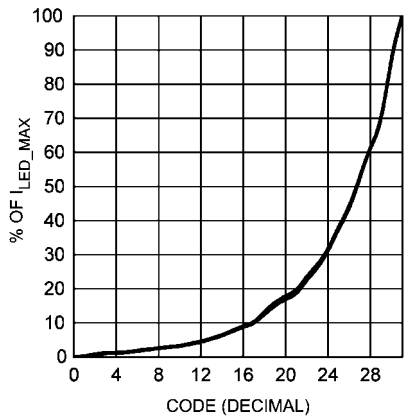

30004324

**$I_{LED}$  vs Current Source Headroom Voltage**  
( $V_{IN} = 3\text{V}$ , UNI = '0')

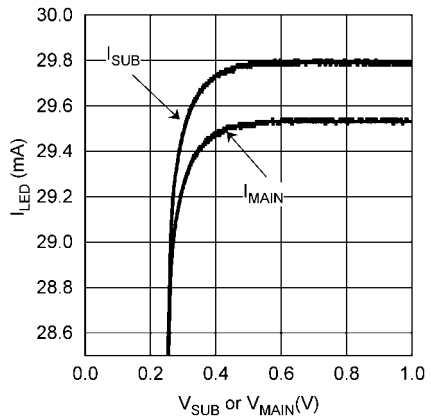

30004360

**Start-Up Waveform (LED Mode)**  
(2 x 5 LEDs, 30mA per string)

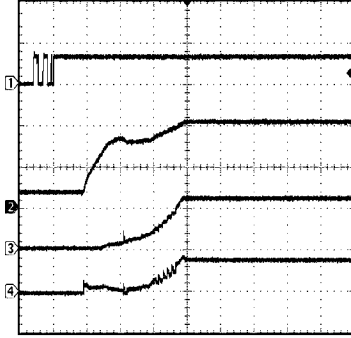

30004325

Channel 1: SDA (5V/div)  
Channel 2:  $V_{OUT}$  (10V/div)  
Channel 3:  $I_{LED}$  (50mA/div)  
Channel 4:  $I_{IN}$  (500mA/div)  
Time Base: 400 $\mu$ s/div

**Start-Up Waveform (OLED Mode)**  
( $V_{OUT} = 18V$ ,  $I_{OUT} = 60mA$ )

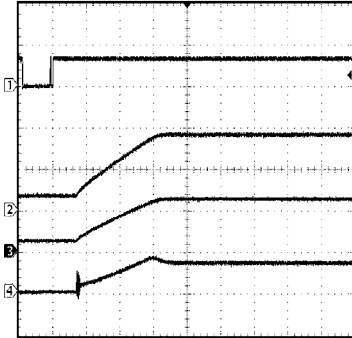

30004327

Channel 1: SDA (5V/div)  
Channel 2:  $V_{OUT}$  (10V/div)  
Channel 3:  $I_{OUT}$  (50mA/div)  
Channel 4:  $I_{IN}$  (500mA/div)  
Time Base: 400 $\mu$ s/div

**Load Step (OLED Mode)**  
( $V_{OUT} = 18V$ ,  $C_{OUT} = 2.2\mu F$ )

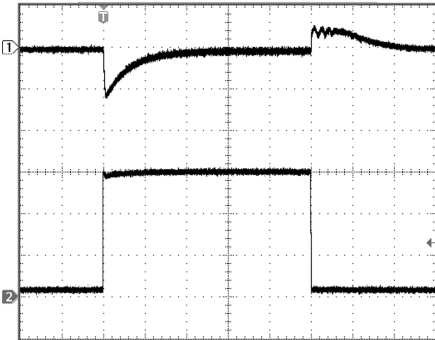

30004326

Channel 1:  $V_{OUT}$  (AC Coupled, 500mV/div)  
Channel 2:  $I_{OUT}$  (20mA/div)  
Time Base: 200 $\mu$ s/div

**Line Step (LED Mode)**  
(2 x 5 LEDs, 30mA per String,  $C_{OUT} = 1\mu F$ )



30004354

Channel 1:  $V_{OUT}$  (AC Coupled, 500mV/div)  
Channel 2:  $V_{IN}$  (AC Coupled, 500mV/div)  
Time Base: 200 $\mu$ s/div

**Transition From OLED to OLED + 1 x 4 LED)**  
( $V_{OUT} = 18V$ ,  $I_{OUT} = 40mA$ ,  $I_{LED} = 20mA$ ,  $C_{OUT} = 2.2\mu F$ )

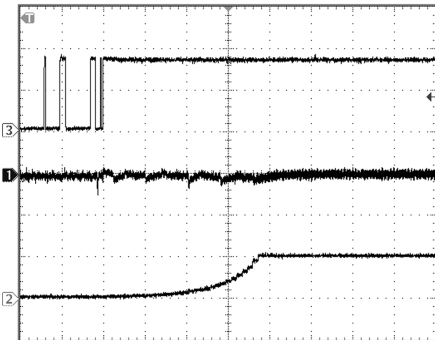

30004328

Channel 3: SDA (2V/div)  
Channel 1:  $V_{OUT}$  (AC Coupled, 200mV/div)  
Channel 2:  $I_{MAIN}$  (20mA/div)  
Time Base: 400 $\mu$ s/div

**RESET Functionality**

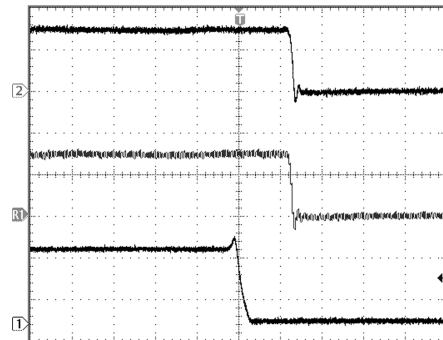

30004352

Channel 2:  $I_{SUB}$  (20mA/div)  
Channel R1:  $I_{MAIN}$  (20mA/div)  
Channel 1:  $\overline{RESET}$  (2V/div)  
Time Base: 200ns/div

**GPIO Functionality**  
(GPIO Configured as OUTPUT,  $f_{SCL} = 200kHz$ )

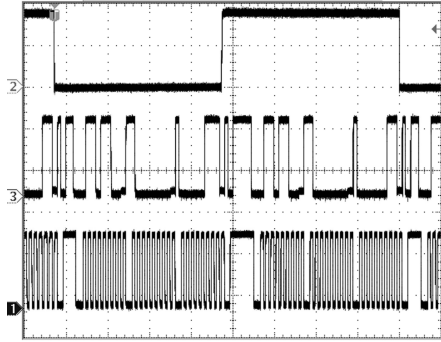

30004353

Channel 2: GPIO (2V/div)  
Channel 3: SDA (2V/div)  
Channel 1: SCL (2V/div)  
Time Base: 40 $\mu$ s/div

**Ramp Rate Functionality**  
(RMP1, RMP0 = '00')

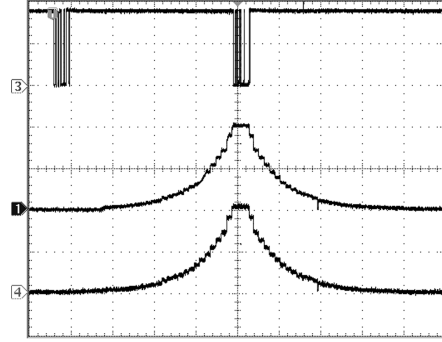

30004330

Channel 3: SDA (2V/div)  
Channel 1:  $I_{MAIN}$  (10mA/div)  
Channel 4:  $I_{SUB}$  (10mA/div)  
Time Base: 40 $\mu$ s/div

**Ramp Rate Functionality**  
(RMP1, RMP0 = '01')

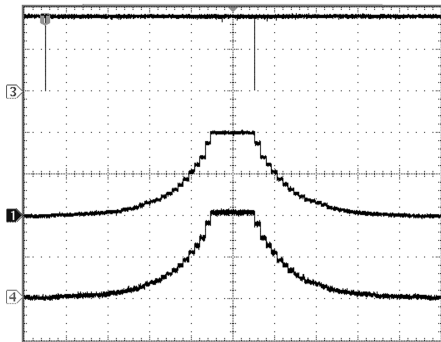

30004355

Channel 3: SDA (2V/div)  
Channel 1:  $I_{MAIN}$  (10mA/div)  
Channel 4:  $I_{SUB}$  (10mA/div)  
Time Base: 100ms/div

**Ramp Rate Functionality**  
(RMP1, RMP0 = '10')

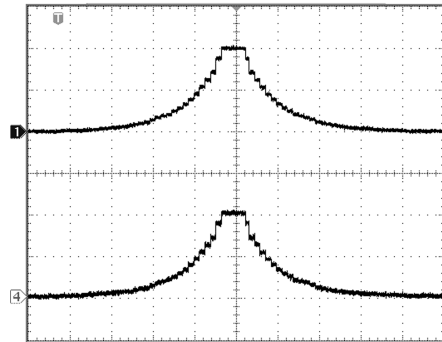

30004356

Channel 1:  $I_{MAIN}$  (10mA/div)  
Channel 4:  $I_{SUB}$  (10mA/div)  
Time Base: 200ms/div

**Ramp Rate Functionality**  
(RMP1, RMP0 = '11')

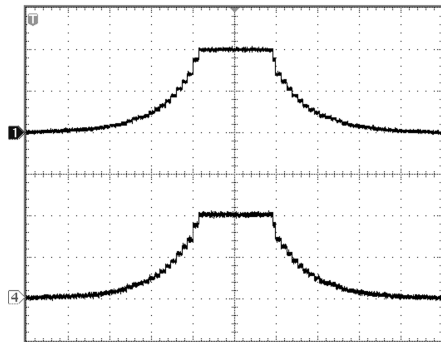

30004351

Channel 1:  $I_{MAIN}$  (10mA/div)  
Channel 4:  $I_{SUB}$  (10mA/div)  
Time Base: 400ms/div

## Block Diagram

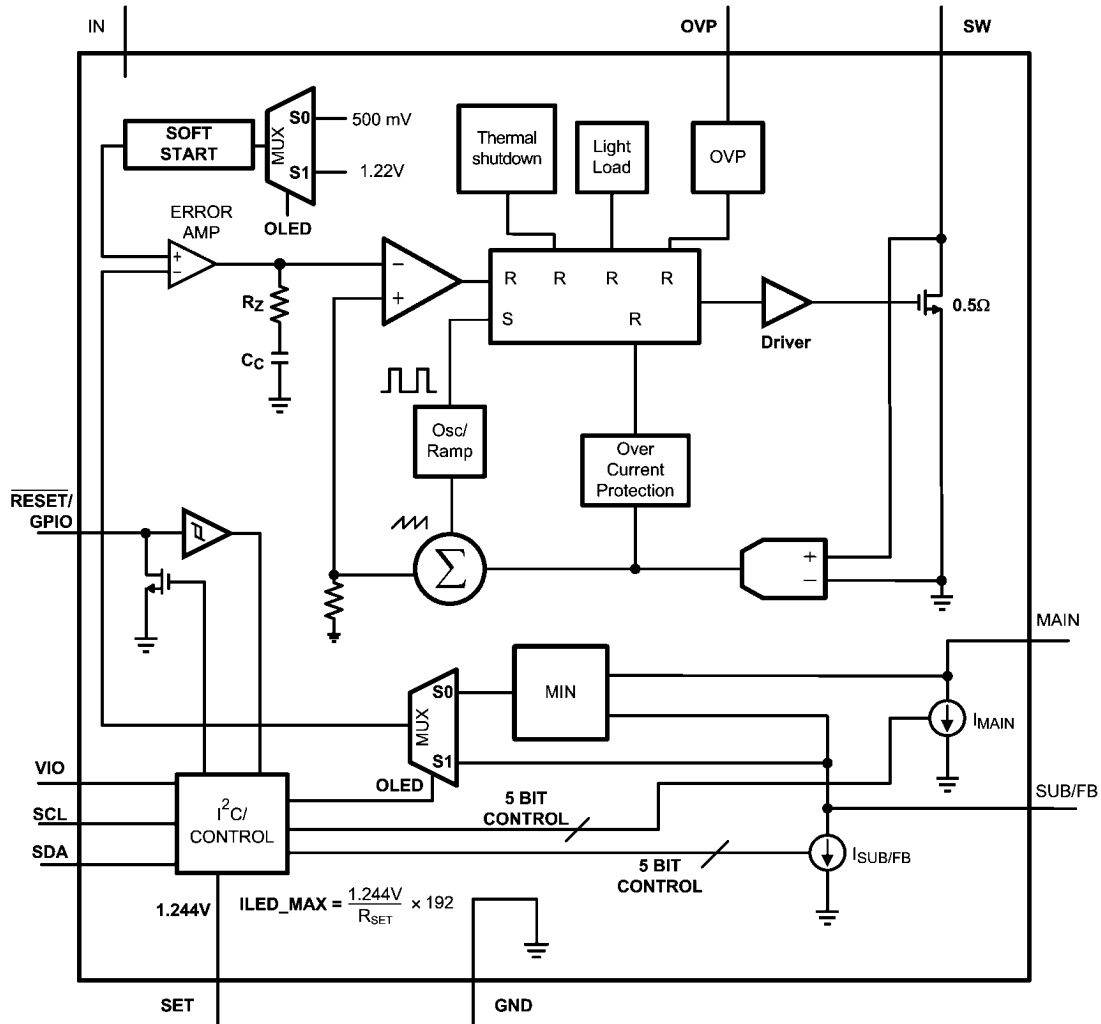

30004333

FIGURE 2. LM3509 Block Diagram

## Operation Description

The LM3509 Current Mode PWM boost converter operates from a 2.7V to 5.5V input and provides two regulated outputs for White LED and OLED display biasing. The first output, MAIN, provides a constant current of up to 30mA to bias up to 5 series white LED's. The second output, SUB/FB, can be configured as a current source for up to 5 series white LED's at at 30mA, or as a feedback voltage pin to regulate a constant output voltage of up to 21V. When both MAIN and SUB/FB are configured for white LED bias the current for each LED string is controlled independently or in unison via an I<sup>2</sup>C compatible interface. When MAIN is configured for white LED bias and SUB/FB is configured as a feedback voltage pin, the current into MAIN is controlled via the I<sup>2</sup>C compatible interface and SUB/FB becomes the middle tap of a resistive divider used to regulate the output voltage of the boost converter.

The core of the LM3509 is a Current Mode Boost converter. Operation is as follows. At the start of each switching cycle the internal oscillator sets the PWM converter. The converter turns the NMOS switch on, allowing the inductor current to

ramp while the output capacitor supplies power to the white LED's and/or OLED panel. The error signal at the output of the error amplifier is compared against the sensed inductor current. When the sensed inductor current equals the error signal, or when the maximum duty cycle is reached, the NMOS switch turns off causing the external Schottky diode to pick up the inductor current. This allows the inductor current to ramp down causing its stored energy to charge the output capacitor and supply power to the load. At the end of the clock period the PWM controller is again set and the process repeats itself.

### ADAPTIVE REGULATION

When biasing dual white led strings (White LED mode) the LM3509 maximizes efficiency by adaptively regulating the output voltage. In this configuration the 500mV reference is connected to the non-inverting input of the error amplifier via mux S2 (see Figure 2, Block Diagram). The lowest of either  $V_{MAIN}$  or  $V_{SUB/FB}$  is then applied to the inverting input of the error amplifier via mux S1. This ensures that  $V_{MAIN}$  and  $V_{SUB/FB}$  are at least 500mV, thus providing enough voltage head-

room at the input to the current sinks for proper current regulation.

In the instance when there are unequal numbers of LEDs or unequal currents from string to string, the string with the highest voltage will be the regulation point.

### UNISON/NON-UNISON MODE

Within White LED mode there are two separate modes of operation, Unison and Non-Unison. Non-Unison mode provides for independent current regulation, while Unison mode gives up independent regulation for more accurate matching between LED strings. When in Non-Unison mode the LED currents  $I_{MAIN}$  and  $I_{SUB/FB}$  are independently controlled via registers BMAIN and BSUB respectively (see Brightness Registers (BMAIN and BSUB) section). When in Unison mode BSUB is disabled and both  $I_{MAIN}$  and  $I_{SUB/FB}$  are controlled via BMAIN only.

### START-UP

The LM3509 features an internal soft-start, preventing large inrush currents during start-up that can cause excessive voltage ripple on the input. For the typical application circuits when the device is brought out of shutdown the average input current ramps from zero to 450mA in 1.2ms. See Start Up Plots in the Typical Performance Characteristics.

### OLED MODE

When the LM3509 is configured for a single White LED bias + OLED display bias (OLED mode), the non-inverting input of the error amplifier is connected to the internal 1.21V reference via MUX S2. MUX S1 switches SUB/FB to the inverting input of the error amplifier while disconnecting the internal current sink at SUB/FB. The voltage at MAIN is not regulated in OLED mode so when the application requires white LED + OLED panel biasing, ensure that at least 300mV of headroom is maintained at MAIN to guarantee proper regulation of  $I_{MAIN}$ . (see the Typical Performance Characteristics for a plot of  $I_{LED}$  vs Current Source Headroom Voltage)

### PEAK CURRENT LIMIT

The LM3509's boost converter has a peak current limit for the internal power switch of 770mA typical (650mA minimum). When the peak switch current reaches the current limit the duty cycle is terminated resulting in a limit on the maximum output current and thus the maximum output power the LM3509 can deliver. Calculate the maximum LED current as a function of  $V_{IN}$ ,  $V_{OUT}$ , L and  $I_{PEAK}$  as:

$$I_{OUT\_MAX} = \frac{(I_{PEAK} - \Delta I_L) \times \eta \times V_{IN}}{V_{OUT}}$$

$$\text{where } \Delta I_L = \frac{V_{IN} \times (V_{OUT} - V_{IN})}{2 \times f_{SW} \times L \times V_{OUT}}$$

$f_{SW} = 1.27\text{MHz}$ . Typical values for efficiency and  $I_{PEAK}$  can be found in the efficiency and  $I_{PEAK}$  curves in the Typical Performance Characteristics.

### OVER VOLTAGE PROTECTION

The LM3509's output voltage ( $V_{OUT}$ ) is limited on the high end by the Output Over-Voltage Protection Threshold ( $V_{OVP}$ ) of

21.2V. In White LED mode during output open circuit conditions the output voltage will rise to the over voltage protection threshold ( $V_{OVP} = 21.2\text{V min}$ ). When this happens the controller will stop switching causing  $V_{OUT}$  to droop. When the output voltage drops below 19.7V (min) the device will resume switching. If the device remains in an over voltage condition the LM3509 will repeat the cycle causing the output to cycle between the high and low OVP thresholds. See waveform for OVP condition in the Typical Performance Characteristics.

### OUTPUT CURRENT ACCURACY AND CURRENT MATCHING

The LM3509 provides both precise current accuracy (% error from ideal value) and accurate current matching between the MAIN and SUB/FB current sinks. Two modes of operation affect the current matching between  $I_{MAIN}$  and  $I_{SUB/FB}$ . The first mode (Non-Unison mode) is set by writing a 0 to bit 2 of the General Purpose register (UNI bit). Non-Unison mode allows for independent programming of  $I_{MAIN}$  and  $I_{SUB/FB}$  via registers BMAIN and BSUB respectively. In this mode typical matching between current sinks is 1%.

Writing a 1 to UNI configures the device for Unison mode. In Unison mode, BSUB is disabled and  $I_{MAIN}$  and  $I_{SUB/FB}$  are both controlled via register BMAIN. In this mode typical matching is 0.15%.

### LIGHT LOAD OPERATION

The LM3509 boost converter operates in three modes; continuous conduction, discontinuous conduction, and skip mode operation. Under heavy loads when the inductor current does not reach zero before the end of the switching period the device switches at a constant frequency. As the output current decreases and the inductor current reaches zero before the end of the switching cycle, the device operates in discontinuous conduction. At very light loads the LM3509 will enter skip mode operation causing the switching period to lengthen and the device to only switch as required to maintain regulation at the output.

### ACTIVE LOW RESET/GENERAL PURPOSE I/O ( $\overline{\text{RESET}}$ /GPIO)

The  $\overline{\text{RESET}}$ /GPIO serves as an active low reset input or as a general-purpose logic input/output. Upon power-up of the device  $\overline{\text{RESET}}$ /GPIO defaults to the active low reset mode. The functionality of  $\overline{\text{RESET}}$ /GPIO is set via the GPIO register and is detailed in Table 6. When configured as an active low reset input, (Bit 0 = 0), pulling  $\overline{\text{RESET}}$ /GPIO low automatically programs all registers of the LM3509 with 0x00. Their state cannot be changed until  $\overline{\text{RESET}}$ /GPIO is pulled high. The General Purpose I/O (GPIO) register is used to enable the GPIO function of the  $\overline{\text{RESET}}$ /GPIO pin. The GPIO register is an 8-bit register with only the 3 LSB's active. The 5 MSB's are not used. When configured as an output,  $\overline{\text{RESET}}$ /GPIO is open drain and requires an external pull-up resistor.

### THERMAL SHUTDOWN

The LM3509 offers a thermal shutdown protection. When the die temperature reaches +140°C the device will shutdown and not turn on again until the die temperature falls below +120°C.

**I<sup>2</sup>C COMPATIBLE INTERFACE**

The LM3509 is controlled via an I<sup>2</sup>C compatible interface. START and STOP conditions classify the beginning and the end of the I<sup>2</sup>C session. A START condition is defined as SDA transitioning from HIGH to LOW while SCL is HIGH. A STOP condition is defined as SDA transitioning from LOW to HIGH while SCL is HIGH. The I<sup>2</sup>C master always generates START and STOP conditions. The I<sup>2</sup>C bus is considered busy after a

START condition and free after a STOP condition. During data transmission, the I<sup>2</sup>C master can generate repeated START conditions. A START and a repeated START conditions are equivalent function-wise. The data on SDA must be stable during the HIGH period of the clock signal (SCL). In other words, the state of SDA can only be changed when SCL is LOW.

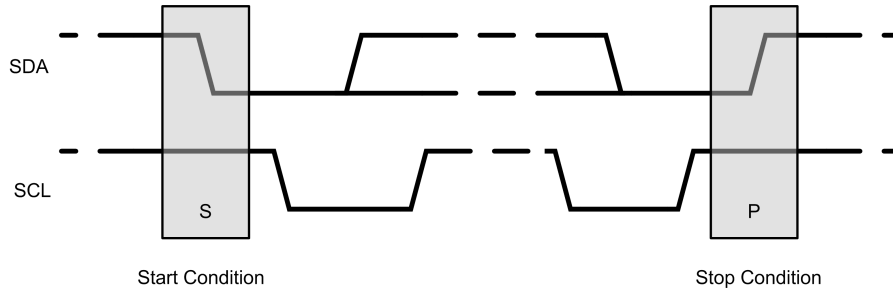

30004337

**FIGURE 3. Start and Stop Sequences**

**I<sup>2</sup>C COMPATIBLE ADDRESS**

The chip address for the LM3509 is 0110110 (36h). After the START condition, the I<sup>2</sup>C master sends the 7-bit chip address followed by a read or write bit (R/W). R/W= 0 indicates a

WRITE and R/W = 1 indicates a READ. The second byte following the chip address selects the register address to which the data will be written. The third byte contains the data for the selected register.

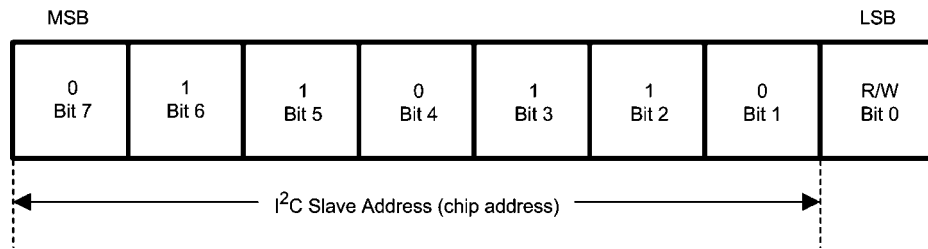

30004338

**FIGURE 4. Chip Address**

**TRANSFERRING DATA**

Every byte on the SDA line must be eight bits long, with the most significant bit (MSB) transferred first. Each byte of data must be followed by an acknowledge bit (ACK). The acknowledge related clock pulse (9th clock pulse) is generated by the master. The master releases SDA (HIGH) during the 9th clock

pulse. The LM3509 pulls down SDA during the 9th clock pulse, signifying an acknowledge. An acknowledge is generated after each byte has been received. Figure 5 is an example of a write sequence to the General Purpose register of the LM3509.

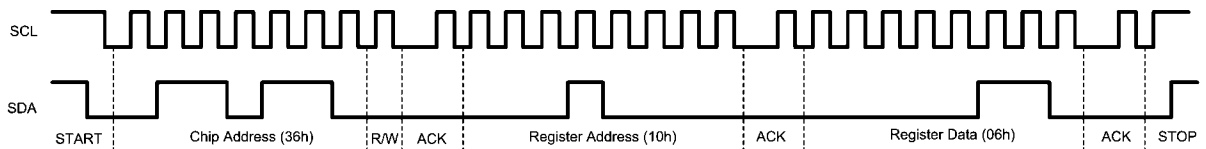

30004339

**FIGURE 5. Write Sequence to the LM3509**

## REGISTER DESCRIPTIONS

There are 4, 8 bit registers within the LM3509 as detailed in *Table 1*.

**TABLE 1. LM3509 Register Descriptions**

Register Name	Hex Address	Power -On-Value
General Purpose (GP)	10	0xC0
Brightness Main (BMAIN)	A0	0xE0
Brightness Sub (BSUB)	B0	0xE0
General Purpose I/O (GPIO)	80	0XF8

**GENERAL PURPOSE REGISTER (GP)**

The General Purpose register has four functions. It controls the on/off state of MAIN and SUB/FB, it selects between Unison or Non-Unison mode, provides for control over the rate of

change of the LED current (see Brightness Rate of Change Description), and selects between White LED and OLED mode. Figure 6 and Table 2 describes each bit available within the General Purpose Register.

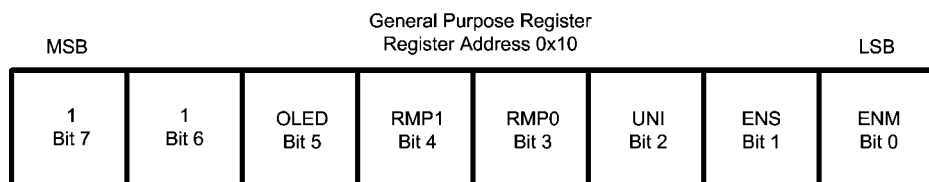

30004340

**FIGURE 6. General Purpose Register Description**

**TABLE 2. General Purpose Register Bit Function**

Bit	Name	Function	Power-On-Value
0	ENM	Enable MAIN. Writing a 1 to this bit enables the main current sink (MAIN). Writing a 0 to this bit disables the main current sink and forces MAIN high impedance.	0
1	ENS	Enable SUB/FB. Writing a 1 to this bit enables the secondary current sink (SUB/FB). Writing a 0 to this bit disables the secondary current sink and forces SUB/FB high impedance.	0
2	UNI	Unison Mode Select. Writing a 1 to this bit disables the BSUB register and causes the contents of BMAIN to set the current in both the MAIN and SUB/FB current sinks. Writing a 0 to this bit allows the current into MAIN and SUB/FB to be independently controlled via the BMAIN and BSUB registers respectively.	0
3	RMP0	Brightness Rate of Change. Bits RMP0 and RMP1 set the rate of change of the LED current into MAIN and SUB/FB in response to changes in the contents of registers BMAIN and BSUB (see brightness rate of change description).	0
4	RMP1		0
5	OLED	OLED = 0 places the LM3509 in White LED mode. In this mode both the MAIN and SUB/FB current sinks are active. The boost converter ensures there is at least 500mV at $V_{MAIN}$ and $V_{SUB/FB}$ .  OLED = 1 places the LM3509 in OLED mode. In this mode the boost converter regulates $V_{SUB/FB}$ to 1.25V. $V_{MAIN}$ is unregulated and must be > 400mV for the MAIN current sink to maintain current regulation.	0
6	Don't Care	These are non-functional read only bits. They will always read back as a 1.	1
7			

**TABLE 3. Operational Truth Table**

UNI	OLED	ENM	ENS	Result
X	0	0	0	LM3509 Disabled
1	0	1	X	MAIN and SUB/FB current sinks enabled. Current levels set by contents of BMAIN.
1	0	0	X	MAIN and SUB/FB Disabled
0	0	0	1	SUB/FB current sink enabled. Current level set by BSUB.
0	0	1	0	MAIN current sink enabled. Current level set by BMAIN.
0	0	1	1	MAIN and SUB/FB current sinks enabled. Current levels set by contents of BMAIN and BSUB respectively.
X	1	1	X	SUB/FB current sink disabled (SUB/FB configured as a feedback pin). MAIN current sink enabled current level set by BMAIN.
X	1	0	X	SUB/FB current sink disabled (SUB/FB configured as a feedback pin). MAIN current sink disabled.

\* ENM ,ENS, or OLED high enables analog circuitry.

#### BRIGHTNESS REGISTERS (BMAIN and BSUB)

With the UNI bit (General Purpose register) set to 0 (Non-Unison mode) both brightness registers (BMAIN and BSUB) independently control the LED currents  $I_{MAIN}$  and  $I_{SUB/FB}$  respectively. BMAIN and BSUB are both 8 bit, but with only the 5 LSB's controlling the current. The three MSB's are don't cares. The LED current control is designed to approximate an exponentially increasing response of the LED current vs increasing code in either BMAIN or BSUB (see Figure 9). Program  $I_{LED\_MAX}$  by connecting a resistor (RSET) from SET to GND, where:

$$I_{LED\_MAX} = 192 \times \frac{1.244V}{R_{SET}}$$

. With the UNI bit (General Purpose register) set to 1 (Unison mode), BSUB is disabled and BMAIN sets both  $I_{MAIN}$  and  $I_{SUB/FB}$ . This prevents the independent control of  $I_{MAIN}$  and  $I_{SUB/FB}$ , however matching between current sinks goes from typically 1% (with UNI = 0) to typically 0.15% (with UNI = 1). Figure 7 and Figure 8 show the register descriptions for the Brightness MAIN and Brightness SUB registers. Table 4 and Figure 9 show  $I_{MAIN}$  and/or  $I_{SUB/FB}$  vs. brightness data as a percentage of  $I_{LED\_MAX}$ .

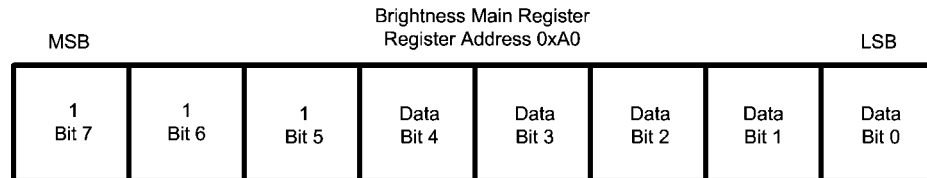

30004342

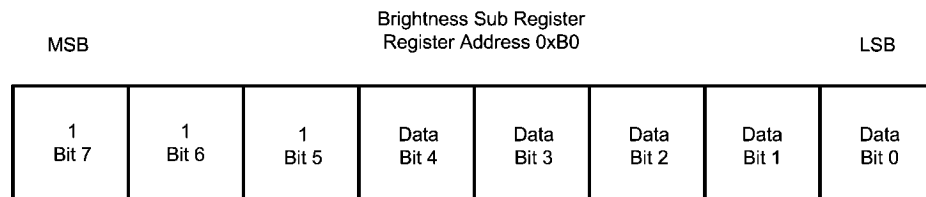
**FIGURE 7. Brightness MAIN Register Description**

30004343

**FIGURE 8. Brightness SUB Register Description**



**TABLE 4.  $I_{LED}$  vs. Brightness Register Data**

BMAIN or BSUB Brightness Data	% of ILED_MAX	BMAIN or BSUB Brightness Data	% of ILED_MAX
00000	0.000%	10000	8.750%
00001	0.125%	10001	10.000%
00010	0.625%	10010	12.500%
00011	1.000%	10011	15.000%
00100	1.125%	10100	16.875%
00101	1.313%	10101	18.750%
00110	1.688%	10110	22.500%
00111	2.063%	10111	26.250%
01000	2.438%	11000	31.250%
01001	2.813%	11001	37.500%
01010	3.125%	11010	43.750%
01011	3.750%	11011	52.500%
01100	4.375%	11100	61.250%
01101	5.250%	11101	70.000%
01110	6.250%	11110	87.500%
01111	7.500%	11111	100.000%

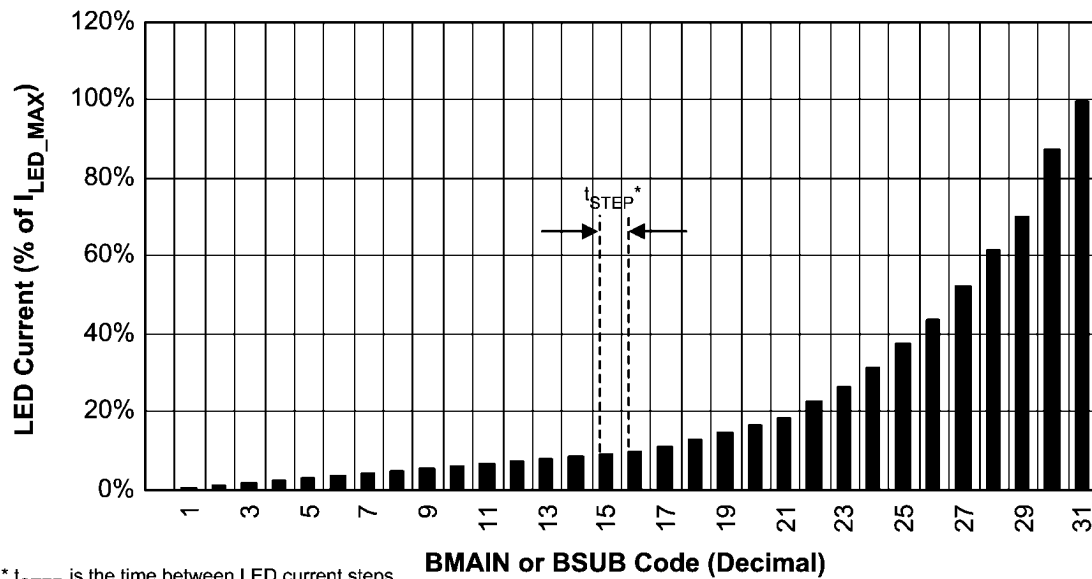

\*  $t_{STEP}$  is the time between LED current steps programmed via bits RMP0, RMP1

30004344

**FIGURE 9.  $I_{MAIN}$  or  $I_{SUB}$  vs BMAIN or BSUB Data**

**BRIGHTNESS RATE OF CHANGE DESCRIPTION**

RMP0 and RMP1 control the rate of change of the LED current  $I_{MAIN}$  and  $I_{SUB/FB}$  in response to changes in BMAIN and / or BSUB. There are 4 user programmable LED current rates of change settings for the LM3509 (see *Table 5*).

**TABLE 5. Rate of Change Bits**

RMP0	RMP1	Change Rate ( $t_{STEP}$ )
0	0	51 $\mu$ s/step
0	1	13ms/step
1	0	26ms/step
1	1	52ms/step

For example, if  $R_{SET} = 12k\Omega$  then  $I_{LED\_MAX} = 20mA$ . With the contents of BMAIN set to 0x1F ( $I_{MAIN} = 20mA$ ), suppose the contents of BMAIN are changed to 0x00 resulting in ( $I_{MAIN} = 0mA$ ). With RMP0 = 1 and RMP1 = 1 (52ms/step),  $I_{MAIN}$  will change from 20mA to 0mA in 31 steps with 52ms elapsing between steps, excluding the step from 0x1F to 0x1E, resulting in a full scale current change in 1560ms. The total time to transition from one brightness code to another is:

$$t_{transition} = (|InitialCode - FinalCode| - 1) \times t_{STEP}$$

The following 3 additional examples detail possible scenarios when using the brightness register in conjunction with the rate of change bits and the enable bits.

**Example 1:**

Step 1: Write to BMAIN a value corresponding to  $I_{MAIN} = 20mA$ .

Step 2: Write 1 to ENM (turning on MAIN)

Step 3:  $I_{MAIN}$  ramps to 20mA with a rate set by RMP0 and RMP1. (RMP0 and RMP1 bits set the duration spent at one brightness code before incrementing to the next).

Step 4: ENM is set to 0 before 20mA is reached, thus the LED current fades off at a rate given by RMP0 and RMP1 without  $I_{MAIN}$  going up to 20mA.

**Example 2:**

Step 1: ENM is 1, and BMAIN has been programmed with code 0x01. This results in a small current into MAIN.

Step 2: BMAIN is programmed with 0x1F (full scale current). This causes  $I_{MAIN}$  to ramp toward full-scale at the rate selected by RMP0 and RMP1.

Step 3: Before  $I_{MAIN}$  reaches full-scale BMAIN is programmed with 0x09.  $I_{MAIN}$  will continue to ramp to full scale.

Step 4: When  $I_{MAIN}$  has reached full-scale value it will ramp down to the current corresponding to 0x09 at a rate set by RMP0 and RMP1.

**Example 3:**

Step 1: Write to BMAIN a value corresponding to  $I_{MAIN} = 20mA$ .

Step 2: Write a 1 to both RMP0 and RMP1.

Step 3: Write 1 to ENM (turning on MAIN).

Step 4:  $I_{MAIN}$  ramps toward 20mA with a rate set by RMP0 and RMP1. (RMP0 and RMP1 bits set the duration spent at one brightness code before incrementing to the next).

Step 5: After 1.04s  $I_{MAIN}$  has ramped to 16.875% of  $I_{LED\_MAX}$  ( $0.16875 \times 20mA = 3.375mA$ ). Simultaneously, RMP0 and RMP1 are both programmed with 0.

Step 6:  $I_{MAIN}$  continues ramping from 3.375mA to 20mA, but at a new ramp rate of 51 $\mu$ s/step.

**TABLE 6. GPIO Register Function**

Bits 7 – 3	Data (Bit 2)	Mode (Bit 1)	Enable GPIO (Bit 0)	Function
X	X	X	0	RESET/GPIO is configured as an active low reset input. This is the default power on state.
X	Logic Input	0	1	RESET/GPIO is configured as a logic input. The logic level applied to RESET/GPIO can be read via bit 2 of the GPIO register.
X	Logic Output	1	1	RESET/GPIO is configured as a logic output. A 0 in bit 2 forces RESET/GPIO low. A 1 in bit 2 forces RESET/GPIO high impedance.

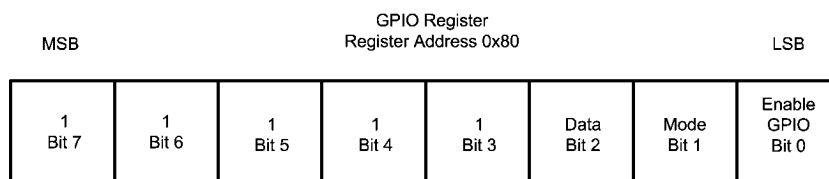

30004346

**FIGURE 10. GPIO Register Description****SHUTDOWN AND OUTPUT ISOLATION**

The LM3509 provides a true shutdown for either MAIN or SUB/FB when configured as a White LED bias supply. Write a 0 to ENM (bit 1) of the General Purpose register to turn off the MAIN current sink and force MAIN high impedance. Write a 0 to ENS (bit 2) of the General Purpose register to turn off

the SUB/FB current sink and force SUB/FB high impedance. Writing a 1 to ENM or ENS turns on the MAIN and SUB/FB current sinks respectively. When in shutdown the leakage current into MAIN or SUB/FB is typically 3.6 $\mu$ A. See Typical Performance Plots for start-up responses of the LM3509 using the ENM and ENS bits in White LED and OLED modes.

## Application Information

### LED CURRENT SETTING/MAXIMUM LED CURRENT

Connect a resistor ( $R_{SET}$ ) from SET to GND to program the maximum LED current ( $I_{LED\_MAX}$ ) into MAIN or SUB/FB. The  $R_{SET}$  to  $I_{LED\_MAX}$  relationship is:

$$I_{LED\_MAX} = 192 \times \frac{1.244V}{R_{SET}}$$

where SET provides the constant 1.244V output.

### OUTPUT VOLTAGE SETTING (OLED MODE)

Connect Feedback resistors from the converters output to SUB/FB to GND to set the output voltage in OLED mode (see R1 and R2 in the Typical Application Circuit (OLED Panel Power Supply)). First select  $R2 < 100k\Omega$  then calculate R1 such that:

$$R1 = R2 \left( \frac{V_{OUT}}{1.21V} - 1 \right)$$

In OLED mode the MAIN current sink continues to regulate the current through MAIN, however,  $V_{MAIN}$  is no longer regulated. To avoid dropout and ensure proper current regulation the application must ensure that  $V_{MAIN} > 0.3V$ .

### OUTPUT CAPACITOR SELECTION

The LM3509's output capacitor supplies the LED current during the boost converters on time. When the switch turns off the inductor energy is discharged through the diode supplying power to the LED's and restoring charge to the output capacitor. This causes a sag in the output voltage during the on time and a rise in the output voltage during the off time. The output capacitor is therefore chosen to limit the output ripple to an acceptable level depending on LED or OLED panel current requirements and input/output voltage differentials. For proper operation ceramic output capacitors ranging from  $1\mu F$  to  $2.2\mu F$  are required.

As with the input capacitor, the output voltage ripple is composed of two parts, the ripple due to capacitor discharge ( $\Delta V_Q$ ) and the ripple due to the capacitors ESR ( $\Delta V_{ESR}$ ). For continuous conduction mode, the ripple components are found by:

$$\Delta V_Q = \frac{I_{LED} \times (V_{OUT} - V_{IN})}{f_{SW} \times V_{OUT} \times C_{OUT}} \quad \text{and}$$

$$\Delta V_{ESR} = R_{ESR} \times \left( \frac{I_{LED} \times V_{OUT}}{V_{IN}} + \Delta I_L \right)$$

$$\text{where } \Delta I_L = \frac{V_{IN} \times (V_{OUT} - V_{IN})}{2 \times f_{SW} \times L \times V_{OUT}}$$

### INPUT CAPACITOR SELECTION

Choosing the correct size and type of input capacitor helps minimize the input voltage ripple caused by the switching of the LM3509's boost converter. For continuous inductor current operation the input voltage ripple is composed of 2 primary components, the capacitor discharge ( $\Delta V_Q$ ) and the capacitor's equivalent series resistance ( $\Delta V_{ESR}$ ). These ripple components are found by:

$$\Delta V_Q = \frac{\Delta I_L \times D}{2 \times f_{SW} \times C_{IN}}$$

and

$$\Delta V_{ESR} = 2 \times \Delta I_L \times R_{ESR}$$

$$\text{where } \Delta I_L = \frac{V_{IN} \times (V_{OUT} - V_{IN})}{2 \times f_{SW} \times L \times V_{OUT}}$$

In the typical application circuit a  $1\mu F$  ceramic input capacitor works well. Since the ESR in ceramic capacitors is typically less than  $5m\Omega$  and the capacitance value is usually small, the input voltage ripple is primarily due to the capacitive discharge. With larger value capacitors such as tantalum or aluminum electrolytic the ESR can be greater than  $0.5\Omega$ . In this case the input ripple will primarily be due to the ESR.

Table 7 lists different manufacturers for various capacitors and their case sizes that are suitable for use with the LM3509. When configured as a dual output LED driver a  $1\mu F$  output capacitor is adequate. In OLED mode for output voltages above 12V a  $2.2\mu F$  output capacitor is required (see Low Output Voltage Operation (OLED) Section).

**TABLE 7. Recommended Output Capacitors**

Manufacturer	Part Number	Value	Case Size	Voltage Rating
TDK	C1608X5R1E105M	1 $\mu$ F	0603	25V
Murata	GRM39X5R105K25D539	1 $\mu$ F	0603	25V
TDK	C2012X5R1E225M	2.2 $\mu$ F	0805	25V
Murata	GRM219R61E225KA12	2.2 $\mu$ F	0805	25V

**INDUCTOR SELECTION**

The LM3509 is designed for use with a 10 $\mu$ H inductor, however 22 $\mu$ H are suitable providing the output capacitor is increased 2x's. When selecting the inductor ensure that the saturation current rating ( $I_{SAT}$ ) for the chosen inductor is high enough and the inductor is large enough such that at the maximum LED current the peak inductor current is less than the LM3509's peak switch current limit. This is done by choosing:

$$I_{SAT} > \frac{I_{LED}}{\eta} \times \frac{V_{OUT}}{V_{IN}} + \Delta I_L \quad \text{where}$$

$$\Delta I_L = \frac{V_{IN} \times (V_{OUT} - V_{IN})}{2 \times f_{SW} \times L \times V_{OUT}}, \text{ and}$$

$$L > \frac{V_{IN} \times (V_{OUT} - V_{IN})}{2 \times f_{SW} \times V_{OUT} \times \left( I_{PEAK} - \frac{I_{LED\_MAX} \times V_{OUT}}{\eta \times V_{IN}} \right)}$$

Values for  $I_{PEAK}$  can be found in the plot of peak current limit vs.  $V_{IN}$  in the Typical Performance Characteristics graphs. *Table 8* shows possible inductors, as well as their corresponding case size and their saturation current ratings.

**TABLE 8. Recommended Inductors**

Manufacturer	Part Number	Value	Dimensions	$I_{SAT}$	DC Resistance
TDK	VLF3012AT-100M R49	10 $\mu$ H	2.6mm×2.8mm×1 mm	490mA	0.36 $\Omega$
TDK	VLF4012AT-100M R79	10 $\mu$ H	3.5mm×3.7mm×1. 2mm	800mA	0.3 $\Omega$
TOKO	A997AS-100M	10 $\mu$ H	3.8mm×3.8mm×1. 8mm	580mA	0.18 $\Omega$

**DIODE SELECTION**

The output diode must have a reverse breakdown voltage greater than the maximum output voltage. The diodes average current rating should be high enough to handle the LM3509's output current. Additionally, the diodes peak current rating must be high enough to handle the peak inductor current. Schottky diodes are recommended due to their lower

forward voltage drop (0.3V to 0.5V) compared to (0.6V to 0.8V) for PN junction diodes. If a PN junction diode is used, ensure it is the ultra-fast type ( $t_{rr} < 50$ ns) to prevent excessive loss in the rectifier. For Schottky diodes the B05030WS (or equivalent) work well for most designs. See Table 9 for a list of other Schottky Diodes with similar performance.

**TABLE 9. Recommended Schottky Diodes**

Manufacturer	Part Number	Package	Reverse Breakdown Voltage	Average Current Rating
Diodes Inc.	B05030WS	SOD-323	30V	0.5A
Philips	BAT760	SOD-323	23V	1A
ON Semiconductor	NSR0320MW2T	SOD-323	30V	1A

### OUTPUT CURRENT RANGE (OLED MODE)

The maximum output current the LM3509 can deliver in OLED mode is limited by 4 factors (assuming continuous conduction); the peak current limit of 770mA (typical), the inductor value, the input voltage, and the output voltage. Calculate the maximum output current ( $I_{OUT\_MAX}$ ) using the following equation:

$$I_{OUT\_MAX} = \frac{(I_{PEAK} - \Delta I_L) \times \eta \times V_{IN}}{V_{OUT}}$$

where

$$\Delta I_L = \frac{V_{IN} \times (V_{OUT} - V_{IN})}{2 \times f_{SW} \times L \times V_{OUT}}$$

For the typical application circuit with  $V_{OUT} = 18V$  and assuming 70% efficiency, the maximum output current at  $V_{IN} = 2.7V$  will be approximately 70mA. At 4.2V due to the shorter on times and lower average input currents the maximum output current (at 70% efficiency) jumps to approximately 105mA. Figure 11 shows a plot of  $I_{OUT\_MAX}$  vs.  $V_{IN}$  using the above equation, assuming 80% efficiency. In reality factors such as current limit and efficiency will vary over  $V_{IN}$ , temperature, and component selection. This can cause the actual  $I_{OUT\_MAX}$  to be higher or lower.

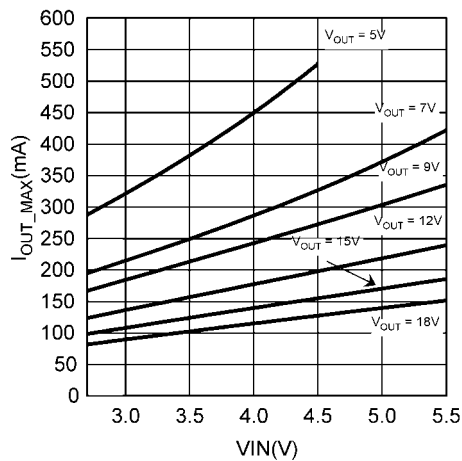

30004362

**FIGURE 11. Typical Maximum Output Current in OLED Mode**

### OUTPUT VOLTAGE RANGE (OLED MODE)

The LM3509's output voltage is constrained by 2 factors. On the low end it is limited by the minimum duty cycle of 10% (assuming continuous conduction) and on the high end it is limited by the over voltage protection threshold ( $V_{OVP}$ ) of 22V (typical). In order to maintain stability when operating at different output voltages the output capacitor and inductor must be changed. Refer to Table 10 for different  $V_{OUT}$ ,  $C_{OUT}$ , and L combinations.

**TABLE 10. Component Values for Output Voltage Selection**

$V_{OUT}$	$C_{OUT}$	L	$V_{IN}$ Range
18V	2.2 $\mu$ F	10 $\mu$ H	2.7V to 5.5V
15V	2.2 $\mu$ F	10 $\mu$ H	2.7V to 5.5V
12V	4.7 $\mu$ F	10 $\mu$ H	2.7V to 5.5V
9V	10 $\mu$ F	10 $\mu$ H	2.7V to 5.5V
7V	10 $\mu$ F	4.7 $\mu$ H	2.7V to 5.5V
5V	22 $\mu$ F	4.7 $\mu$ H	2.7V to 4.5V

### LAYOUT CONSIDERATIONS

The LLP is a leadless package with very good thermal properties. This package has an exposed DAP (die attach pad) at the underside center of the package measuring 1.6mm x 2.0mm. The main advantage of this exposed DAP is to offer low thermal resistance when soldered to the thermal ground pad on the PCB. For good PCB layout a 1:1 ratio between the package and the PCB thermal land is recommended. To further enhance thermal conductivity, the PCB thermal ground pad may include vias to a 2nd layer ground plane. For more detailed instructions on mounting LLP packages, please refer to National Semiconductor Application Note AN-1187.

The high switching frequencies and large peak currents make the PCB layout a critical part of the design. The proceeding steps must be followed to ensure stable operation and proper current source regulation.

- 1, Divide ground into two planes, one for the return terminals of  $C_{OUT}$ ,  $C_{IN}$  and the I<sup>2</sup>C Bus, the other for the return terminals of  $R_{SET}$  and the feedback network. Connect both planes to the exposed PAD, but nowhere else.
- 2, Connect the inductor and the anode of D1 as close together as possible and place this connection as close as possible to the SW pin. This reduces the inductance and resistance of the switching node which minimizes ringing and excess voltage drops. This will improve efficiency and decrease noise that can get injected into the current sources.
- 3, Connect the return terminals of the input capacitor and the output capacitor as close as possible to the exposed PAD and through low impedance traces.
- 4, Bypass IN with at least a 1 $\mu$ F ceramic capacitor. Connect the positive terminal of this capacitor as close as possible to IN.
- 5, Connect  $C_{OUT}$  as close as possible to the cathode of D1. This reduces the inductance and resistance of the output bypass node which minimizes ringing and the excess voltage drops. This will improve efficiency and decrease noise that can get injected into the current sources.
- 6, Route the traces for  $R_{SET}$  and the feedback divider away from the SW node to minimize noise injection.
- 7, Do not connect any external capacitance to the SET pin.

**Physical Dimensions** inches (millimeters) unless otherwise noted

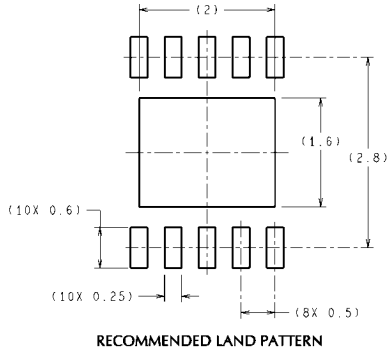

**DIMENSIONS ARE IN MILLIMETERS**  
DIMENSIONS IN ( ) FOR REFERENCE ONLY

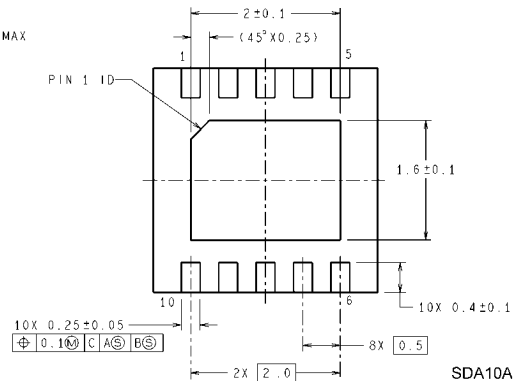
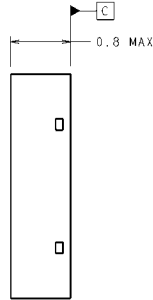
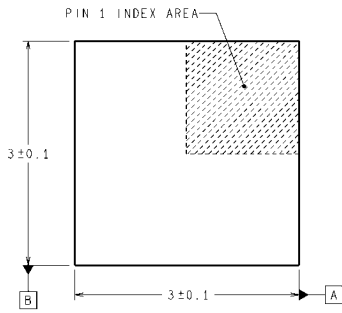
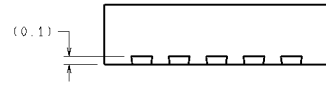

SDA10A (Rev A)

**10 Pin LLP**  
**For Ordering, Refer to Ordering Information Table**  
**NS Package Number SDA10A**  
**X1 = 3mm (±0.1mm), X2 = 3mm (±0.1mm), X3 = 0.8mm**

# Notes

LM3509

## Notes

For more National Semiconductor product information and proven design tools, visit the following Web sites at:

Products		Design Support	
Amplifiers	<a href="http://www.national.com/amplifiers">www.national.com/amplifiers</a>	WEBENCH	<a href="http://www.national.com/webench">www.national.com/webench</a>
Audio	<a href="http://www.national.com/audio">www.national.com/audio</a>	Analog University	<a href="http://www.national.com/AU">www.national.com/AU</a>
Clock Conditioners	<a href="http://www.national.com/timing">www.national.com/timing</a>	App Notes	<a href="http://www.national.com/appnotes">www.national.com/appnotes</a>
Data Converters	<a href="http://www.national.com/adc">www.national.com/adc</a>	Distributors	<a href="http://www.national.com/contacts">www.national.com/contacts</a>
Displays	<a href="http://www.national.com/displays">www.national.com/displays</a>	Green Compliance	<a href="http://www.national.com/quality/green">www.national.com/quality/green</a>
Ethernet	<a href="http://www.national.com/ethernet">www.national.com/ethernet</a>	Packaging	<a href="http://www.national.com/packaging">www.national.com/packaging</a>
Interface	<a href="http://www.national.com/interface">www.national.com/interface</a>	Quality and Reliability	<a href="http://www.national.com/quality">www.national.com/quality</a>
LVDS	<a href="http://www.national.com/lvds">www.national.com/lvds</a>	Reference Designs	<a href="http://www.national.com/refdesigns">www.national.com/refdesigns</a>
Power Management	<a href="http://www.national.com/power">www.national.com/power</a>	Feedback	<a href="http://www.national.com/feedback">www.national.com/feedback</a>
Switching Regulators	<a href="http://www.national.com/switchers">www.national.com/switchers</a>		
LDOs	<a href="http://www.national.com/lido">www.national.com/lido</a>		
LED Lighting	<a href="http://www.national.com/led">www.national.com/led</a>		
PowerWise	<a href="http://www.national.com/powerwise">www.national.com/powerwise</a>		
Serial Digital Interface (SDI)	<a href="http://www.national.com/sdi">www.national.com/sdi</a>		
Temperature Sensors	<a href="http://www.national.com/tempsensors">www.national.com/tempsensors</a>		
Wireless (PLL/VCO)	<a href="http://www.national.com/wireless">www.national.com/wireless</a>		

THE CONTENTS OF THIS DOCUMENT ARE PROVIDED IN CONNECTION WITH NATIONAL SEMICONDUCTOR CORPORATION ("NATIONAL") PRODUCTS. NATIONAL MAKES NO REPRESENTATIONS OR WARRANTIES WITH RESPECT TO THE ACCURACY OR COMPLETENESS OF THE CONTENTS OF THIS PUBLICATION AND RESERVES THE RIGHT TO MAKE CHANGES TO SPECIFICATIONS AND PRODUCT DESCRIPTIONS AT ANY TIME WITHOUT NOTICE. NO LICENSE, WHETHER EXPRESS, IMPLIED, ARISING BY ESTOPPEL OR OTHERWISE, TO ANY INTELLECTUAL PROPERTY RIGHTS IS GRANTED BY THIS DOCUMENT.

TESTING AND OTHER QUALITY CONTROLS ARE USED TO THE EXTENT NATIONAL DEEMS NECESSARY TO SUPPORT NATIONAL'S PRODUCT WARRANTY. EXCEPT WHERE MANDATED BY GOVERNMENT REQUIREMENTS, TESTING OF ALL PARAMETERS OF EACH PRODUCT IS NOT NECESSARILY PERFORMED. NATIONAL ASSUMES NO LIABILITY FOR APPLICATIONS ASSISTANCE OR BUYER PRODUCT DESIGN. BUYERS ARE RESPONSIBLE FOR THEIR PRODUCTS AND APPLICATIONS USING NATIONAL COMPONENTS. PRIOR TO USING OR DISTRIBUTING ANY PRODUCTS THAT INCLUDE NATIONAL COMPONENTS, BUYERS SHOULD PROVIDE ADEQUATE DESIGN, TESTING AND OPERATING SAFEGUARDS.

EXCEPT AS PROVIDED IN NATIONAL'S TERMS AND CONDITIONS OF SALE FOR SUCH PRODUCTS, NATIONAL ASSUMES NO LIABILITY WHATSOEVER, AND NATIONAL DISCLAIMS ANY EXPRESS OR IMPLIED WARRANTY RELATING TO THE SALE AND/OR USE OF NATIONAL PRODUCTS INCLUDING LIABILITY OR WARRANTIES RELATING TO FITNESS FOR A PARTICULAR PURPOSE, MERCHANTABILITY, OR INFRINGEMENT OF ANY PATENT, COPYRIGHT OR OTHER INTELLECTUAL PROPERTY RIGHT.

### LIFE SUPPORT POLICY

**NATIONAL'S PRODUCTS ARE NOT AUTHORIZED FOR USE AS CRITICAL COMPONENTS IN LIFE SUPPORT DEVICES OR SYSTEMS WITHOUT THE EXPRESS PRIOR WRITTEN APPROVAL OF THE CHIEF EXECUTIVE OFFICER AND GENERAL COUNSEL OF NATIONAL SEMICONDUCTOR CORPORATION.** As used herein:

Life support devices or systems are devices which (a) are intended for surgical implant into the body, or (b) support or sustain life and whose failure to perform when properly used in accordance with instructions for use provided in the labeling can be reasonably expected to result in a significant injury to the user. A critical component is any component in a life support device or system whose failure to perform can be reasonably expected to cause the failure of the life support device or system or to affect its safety or effectiveness.

National Semiconductor and the National Semiconductor logo are registered trademarks of National Semiconductor Corporation. All other brand or product names may be trademarks or registered trademarks of their respective holders.

Copyright© 2008 National Semiconductor Corporation

For the most current product information visit us at [www.national.com](http://www.national.com)



**National Semiconductor  
Americas Technical  
Support Center**  
Email:  
[new.feedback@nsc.com](mailto:new.feedback@nsc.com)  
Tel: 1-800-272-9959

**National Semiconductor Europe  
Technical Support Center**  
Email: [europe.support@nsc.com](mailto:europe.support@nsc.com)  
German Tel: +49 (0) 180 5010 771  
English Tel: +44 (0) 870 850 4288

**National Semiconductor Asia  
Pacific Technical Support Center**  
Email: [ap.support@nsc.com](mailto:ap.support@nsc.com)

**National Semiconductor Japan  
Technical Support Center**  
Email: [jpn.feedback@nsc.com](mailto:jpn.feedback@nsc.com)